

VPS 16-1600

Electrical Specifications (@25C)

1. Maximum Power: 25.0VA
2. Secondary: Series: 16.0V CT@ 1.6A
Parallel: 8.0V @ 3.2A
3. Voltage Regulation: 25% TYP @ full load to no load
4. Temperature Rise: 30C TYP (45C MAX allowed)
5. Insulation Resistance: 100MΩ

Construction:

Dual bobbin construction with an insulated shroud, both made of a high temperature material that exceeds UL flammability requirements.

Safety:

These units are designed with 4000VAC isolation between the primary and secondary, and also, between each winding and the core. Since the dual bobbin construction effectively reduces capacitance, electrostatic shielding is not required. World Series Transformers are designed and manufactured to meet the following agency approvals:



Agency File:

UL: File E53148, UL 506, General Purpose.
CSA: File LR 37220. C22.2 NO. 66, General Purpose.
VDE: File 18786-3390-0001, VDE/EN 60 950, (IEC950) information Technology Equipment.

A. Dimensions:

Unit: In inches

H	W	D	A	B	C	T	MW	ML
2-5/16	2-13/16	1-15/16	2	1-1/8	5/16	3/16	2-3/8	-

B. Mounting Hole Size: 3/16"

C. WT Lbs. : 1.25

D. Schematic Diagram:

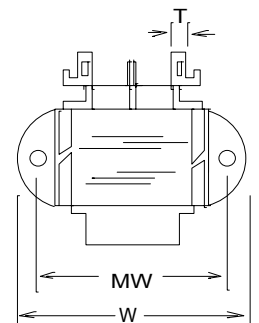
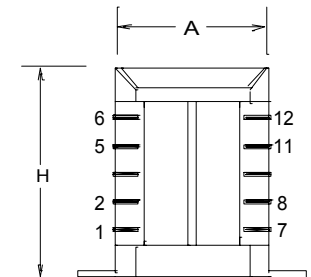
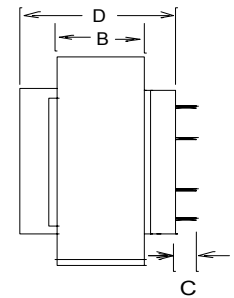
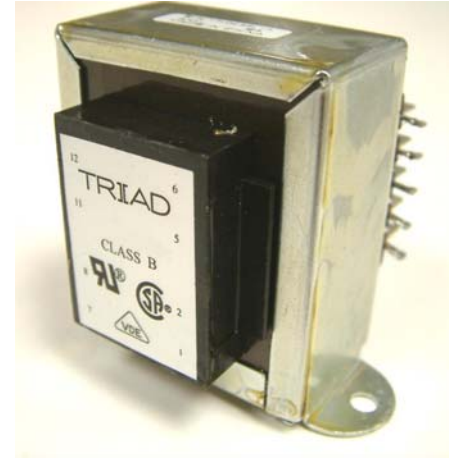
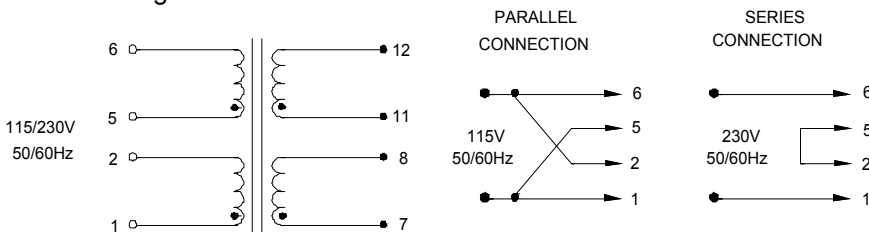

RoHS Compliance: As of manufacturing date February 2005, all standard products meet the requirements of 2002/95/EC, known as the RoHS initiative.

Power Transformers

VDE File: 18786-3390-0001

Class B

UL File: E53148

CSA File: 221330



Chassis Mount: Quick-Connect World Series™

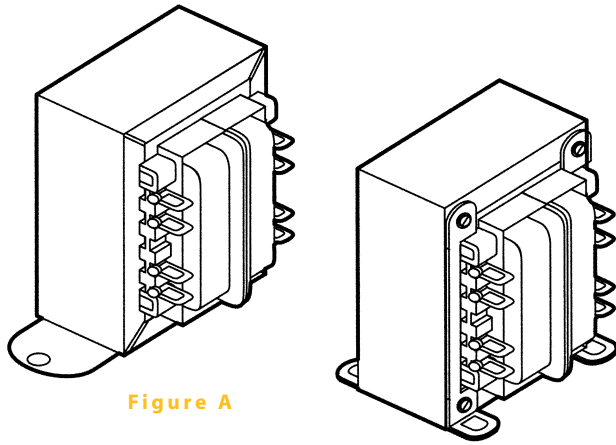

Figure A

Figure B

:: Description

Triad chassis mount World Series transformers are designed to meet U.S. and International standards including CSA, IEC, VDE and UL requirements. The transformers consist of a dual bobbin design positioned inside an insulating shroud and constructed with UL approved high temperature material. This design eliminates the need for electrostatic shielding since there is minimal capacitance between coils when using a dual bobbin configuration. The primary and secondary are both electrically isolated from each other, and from the core itself. Chassis mount World Series transformers are available in sizes ranging from 25 VA to 175 VA, and are equipped with convenient “quick connect” terminations.

:: Specifications

Primary: 115/230 V, 50/60 Hz

:: World Series

Section	Type No.	VA	Secondary		Dimensions							Mounting		Wt. Lbs.	
			Series	Parallel	H	W	D	A	B	C	T	Figure	MW		ML
A	VPS10-2500	25	10.0V CT @ 2.5A	5.0V @ 5.0A	2 ¹ / ₁₆	2 ¹ / ₁₆	1 ¹ / ₁₆	2	1 ¹ / ₈	3 ¹ / ₁₆	3 ¹ / ₁₆	A	2 ³ / ₈	•	1.25
	VPS10-4300	43	10.0V CT @ 4.3A	5.0V @ 8.6A	2 ¹ / ₁₆	3 ¹ / ₈	2	2 ¹ / ₁₆	1 ¹ / ₈	3 ¹ / ₁₆	3 ¹ / ₁₆	A	2 ¹ / ₁₆	•	1.60
	VPS10-8000	80	10.0V CT @ 8.0A	5.0V @ 16.0A	3	2 ¹ / ₂	2 ¹ / ₁₆	•	1 ¹ / ₈	3 ¹ / ₁₆	3 ¹ / ₁₆	B	2	2 ¹ / ₄	2.80
	VPS10-13000	130	10.0V CT @ 13.0A	5.0V @ 26.0A	3 ³ / ₈	2 ¹ / ₁₆	2 ¹ / ₁₆	•	1 ¹ / ₈	3 ¹ / ₈	3 ¹ / ₄	B	2 ¹ / ₄	2 ¹ / ₂	4.10
	VPS10-17500	175	10.0V CT @ 17.5A	5.0V @ 35.0A	3 ³ / ₈	3 ¹ / ₈	2 ¹ / ₁₆	•	1 ¹ / ₈	3 ¹ / ₈	3 ¹ / ₄	B	2 ¹ / ₂	2 ¹ / ₂	5.50
B	VPS12-2000	25	12.6V CT @ 2.0A	6.3V @ 4.0A	2 ¹ / ₁₆	2 ¹ / ₁₆	1 ¹ / ₁₆	2	1 ¹ / ₈	3 ¹ / ₁₆	3 ¹ / ₁₆	A	2 ³ / ₈	•	1.25
	VPS12-3400	43	12.6V CT @ 3.4A	6.3V @ 6.8A	2 ¹ / ₁₆	3 ¹ / ₈	2	2 ¹ / ₁₆	1 ¹ / ₈	3 ¹ / ₁₆	3 ¹ / ₁₆	A	2 ¹ / ₁₆	•	1.60
	VPS12-6300	80	12.6V CT @ 6.3A	6.3V @ 12.6A	3	2 ¹ / ₂	2 ¹ / ₁₆	•	1 ¹ / ₈	3 ¹ / ₁₆	3 ¹ / ₁₆	B	2	2 ¹ / ₄	2.80
	VPS12-10300	130	12.6V CT @ 10.3A	6.3V @ 20.6A	3 ³ / ₈	2 ¹ / ₁₆	2 ¹ / ₁₆	•	1 ¹ / ₈	3 ¹ / ₈	3 ¹ / ₄	B	2 ¹ / ₄	2 ¹ / ₂	4.10
	VPS12-14000	175	12.6V CT @ 14.0A	6.3V @ 28.0A	3 ³ / ₈	3 ¹ / ₈	2 ¹ / ₁₆	•	1 ¹ / ₈	3 ¹ / ₈	3 ¹ / ₄	B	2 ¹ / ₂	2 ¹ / ₂	5.50
C	VPS16-1600	25	16.0V CT @ 1.6A	8.0V @ 3.2A	2 ¹ / ₁₆	2 ¹ / ₁₆	1 ¹ / ₁₆	2	1 ¹ / ₈	3 ¹ / ₁₆	3 ¹ / ₁₆	A	2 ³ / ₈	•	1.25
	VPS16-2700	43	16.0V CT @ 2.7A	8.0V @ 5.4A	2 ¹ / ₁₆	3 ¹ / ₈	2	2 ¹ / ₁₆	1 ¹ / ₈	3 ¹ / ₁₆	3 ¹ / ₁₆	A	2 ¹ / ₁₆	•	1.60
	VPS16-5000	80	16.0V CT @ 5.0A	8.0V @ 10.0A	3	2 ¹ / ₂	2 ¹ / ₁₆	•	1 ¹ / ₈	3 ¹ / ₁₆	3 ¹ / ₁₆	B	2	2 ¹ / ₄	2.80
	VPS16-8100	130	16.0V CT @ 8.1A	8.0V @ 16.2A	3 ³ / ₈	2 ¹ / ₁₆	2 ¹ / ₁₆	•	1 ¹ / ₈	3 ¹ / ₈	3 ¹ / ₄	B	2 ¹ / ₄	2 ¹ / ₂	4.10
	VPS16-11000	175	16.0V CT @ 11.0A	8.0V @ 22.0A	3 ³ / ₈	3 ¹ / ₈	2 ¹ / ₁₆	•	1 ¹ / ₈	3 ¹ / ₈	3 ¹ / ₄	B	2 ¹ / ₂	2 ¹ / ₂	5.50
D	VPS20-1250	25	20.0V CT @ 1.25A	10.0V @ 2.5A	2 ¹ / ₁₆	2 ¹ / ₁₆	1 ¹ / ₁₆	2	1 ¹ / ₈	3 ¹ / ₁₆	3 ¹ / ₁₆	A	2 ³ / ₈	•	1.25
	VPS20-2200	43	20.0V CT @ 2.2A	10.0V @ 4.4A	2 ¹ / ₁₆	3 ¹ / ₈	2	2 ¹ / ₁₆	1 ¹ / ₈	3 ¹ / ₁₆	3 ¹ / ₁₆	A	2 ¹ / ₁₆	•	1.60
	VPS20-4000	80	20.0V CT @ 4.0A	10.0V @ 8.0A	3	2 ¹ / ₂	2 ¹ / ₁₆	•	1 ¹ / ₈	3 ¹ / ₁₆	3 ¹ / ₁₆	B	2	2 ¹ / ₄	2.80
	VPS20-6500	130	20.0V CT @ 6.5A	10.0V @ 13.0A	3 ³ / ₈	2 ¹ / ₁₆	2 ¹ / ₁₆	•	1 ¹ / ₈	3 ¹ / ₈	3 ¹ / ₄	B	2 ¹ / ₄	2 ¹ / ₂	4.10
	VPS20-8800	175	20.0V CT @ 8.8A	10.0V @ 17.6A	3 ³ / ₈	3 ¹ / ₈	2 ¹ / ₁₆	•	1 ¹ / ₈	3 ¹ / ₈	3 ¹ / ₄	B	2 ¹ / ₂	2 ¹ / ₂	5.50
E	VPS24-1000	25	24.0V CT @ 1.0A	12.0V @ 2.0A	2 ¹ / ₁₆	2 ¹ / ₁₆	1 ¹ / ₁₆	2	1 ¹ / ₈	3 ¹ / ₁₆	3 ¹ / ₁₆	A	2 ³ / ₈	•	1.25
	VPS24-1800	43	24.0V CT @ 1.8A	12.0V @ 3.6A	2 ¹ / ₁₆	3 ¹ / ₈	2	2 ¹ / ₁₆	1 ¹ / ₈	3 ¹ / ₁₆	3 ¹ / ₁₆	A	2 ¹ / ₁₆	•	1.60
	VPS24-3300	80	24.0V CT @ 3.3A	12.0V @ 6.6A	3	2 ¹ / ₂	2 ¹ / ₁₆	•	1 ¹ / ₈	3 ¹ / ₁₆	3 ¹ / ₁₆	B	2	2 ¹ / ₄	2.80
	VPS24-5400	130	24.0V CT @ 5.4A	12.0V @ 10.8A	3 ³ / ₈	2 ¹ / ₁₆	2 ¹ / ₁₆	•	1 ¹ / ₈	3 ¹ / ₈	3 ¹ / ₄	B	2 ¹ / ₄	2 ¹ / ₂	4.10
	VPS24-7300	175	24.0V CT @ 7.3A	12.0V @ 14.6A	3 ³ / ₈	3 ¹ / ₈	2 ¹ / ₁₆	•	1 ¹ / ₈	3 ¹ / ₈	3 ¹ / ₄	B	2 ¹ / ₂	2 ¹ / ₂	5.50
F	VPS28-900	25	28.0V CT @ 0.9A	14.0V @ 1.8A	2 ¹ / ₁₆	2 ¹ / ₁₆	1 ¹ / ₁₆	2	1 ¹ / ₈	3 ¹ / ₁₆	3 ¹ / ₁₆	A	2 ³ / ₈	•	1.25
	VPS28-1500	43	28.0V CT @ 1.5A	14.0V @ 3.0A	2 ¹ / ₁₆	3 ¹ / ₈	2	2 ¹ / ₁₆	1 ¹ / ₈	3 ¹ / ₁₆	3 ¹ / ₁₆	A	2 ¹ / ₁₆	•	1.60
	VPS28-2800	80	28.0V CT @ 2.8A	14.0V @ 5.6A	3	2 ¹ / ₂	2 ¹ / ₁₆	•	1 ¹ / ₈	3 ¹ / ₁₆	3 ¹ / ₁₆	B	2	2 ¹ / ₄	2.80
	VPS28-4600	130	28.0V CT @ 4.6A	14.0V @ 9.2A	3 ³ / ₈	2 ¹ / ₁₆	2 ¹ / ₁₆	•	1 ¹ / ₈	3 ¹ / ₈	3 ¹ / ₄	B	2 ¹ / ₄	2 ¹ / ₂	4.10
	VPS28-6250	175	28.0V CT @ 6.25A	14.0V @ 12.5A	3 ³ / ₈	3 ¹ / ₈	2 ¹ / ₁₆	•	1 ¹ / ₈	3 ¹ / ₈	3 ¹ / ₄	B	2 ¹ / ₂	2 ¹ / ₂	5.50
G	VPS36-700	25	36.0V CT @ 0.7A	18.0V @ 1.4A	2 ¹ / ₁₆	2 ¹ / ₁₆	1 ¹ / ₁₆	2	1 ¹ / ₈	3 ¹ / ₁₆	3 ¹ / ₁₆	A	2 ³ / ₈	•	1.25
	VPS36-1200	43	36.0V CT @ 1.2A	18.0V @ 2.4A	2 ¹ / ₁₆	3 ¹ / ₈	2	2 ¹ / ₁₆	1 ¹ / ₈	3 ¹ / ₁₆	3 ¹ / ₁₆	A	2 ¹ / ₁₆	•	1.60
	VPS36-2200	80	36.0V CT @ 2.2A	18.0V @ 4.4A	3	2 ¹ / ₂	2 ¹ / ₁₆	•	1 ¹ / ₈	3 ¹ / ₁₆	3 ¹ / ₁₆	B	2	2 ¹ / ₄	2.80
	VPS36-3600	130	36.0V CT @ 3.6A	18.0V @ 7.2A	3 ³ / ₈	2 ¹ / ₁₆	2 ¹ / ₁₆	•	1 ¹ / ₈	3 ¹ / ₈	3 ¹ / ₄	B	2 ¹ / ₄	2 ¹ / ₂	4.10
	VPS36-4800	175	36.0V CT @ 4.8A	18.0V @ 9.6A	3 ³ / ₈	3 ¹ / ₈	2 ¹ / ₁₆	•	1 ¹ / ₈	3 ¹ / ₈	3 ¹ / ₄	B	2 ¹ / ₂	2 ¹ / ₂	5.50
H	VPS56-2300	80	36.0V CT @ 2.3A	28.0V @ 4.6A	3 ³ / ₈	2 ¹ / ₈	3 ¹ / ₁₆	2 ¹ / ₈	1 ¹ / ₂	3 ¹ / ₈	3 ¹ / ₄	B	2 ¹ / ₄	2 ¹ / ₂	4.2
I	VPS230-110	25	230.0V CT @ 0.11A	115.0V @ 0.22A	2 ¹ / ₁₆	2 ¹ / ₁₆	1 ¹ / ₁₆	2	1 ¹ / ₈	3 ¹ / ₁₆	3 ¹ / ₁₆	A	2 ³ / ₈	•	1.25
	VPS230-190	43	230.0V CT @ 0.19A	115.0V @ 0.38A	2 ¹ / ₁₆	3 ¹ / ₈	2	2 ¹ / ₁₆	1 ¹ / ₈	3 ¹ / ₁₆	3 ¹ / ₁₆	A	2 ¹ / ₁₆	•	1.60
	VPS230-350	80	230.0V CT @ 0.35A	115.0V @ 0.7A	3	2 ¹ / ₂	2 ¹ / ₁₆	•	1 ¹ / ₈	3 ¹ / ₁₆	3 ¹ / ₁₆	B	2	2 ¹ / ₄	2.80
	VPS230-570	130	230.0V CT @ 0.57A	115.0V @ 1.14A	3 ³ / ₈	2 ¹ / ₁₆	2 ¹ / ₁₆	•	1 ¹ / ₈	3 ¹ / ₈	3 ¹ / ₄	B	2 ¹ / ₄	2 ¹ / ₂	4.10
	VPS230-760	175	230.0V CT @ 0.76A	115.0V @ 1.52A	3 ³ / ₈	3 ¹ / ₈	2 ¹ / ₁₆	•	1 ¹ / ₈	3 ¹ / ₈	3 ¹ / ₄	B	2 ¹ / ₂	2 ¹ / ₂	5.50

CT = Center Tap Mounting Hole Sizes: 25 VA, 43 VA = 3/16" 80 VA, 130 VA, 175 VA = 13/64 x 3/8"

:: Outline Dimensions

Technical Notes

1. Hi-pot tested at 4,000 VRMS.
2. Both primary and secondary coils may be connected as either series or parallel, but both must be used simultaneously.

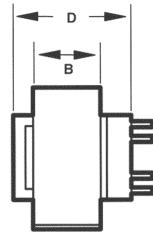
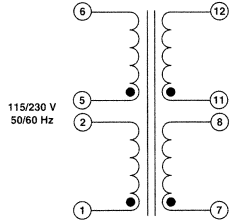

Figure A

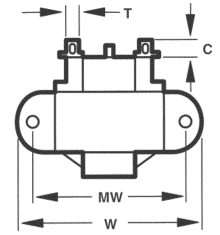
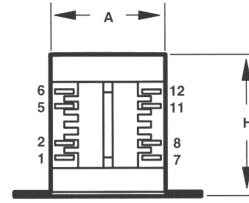

Figure B

